

THANKS FOR WATCHING

Your feedback is invaluable to us and we would love to hear about your experience. Please take the time to leave us a review.

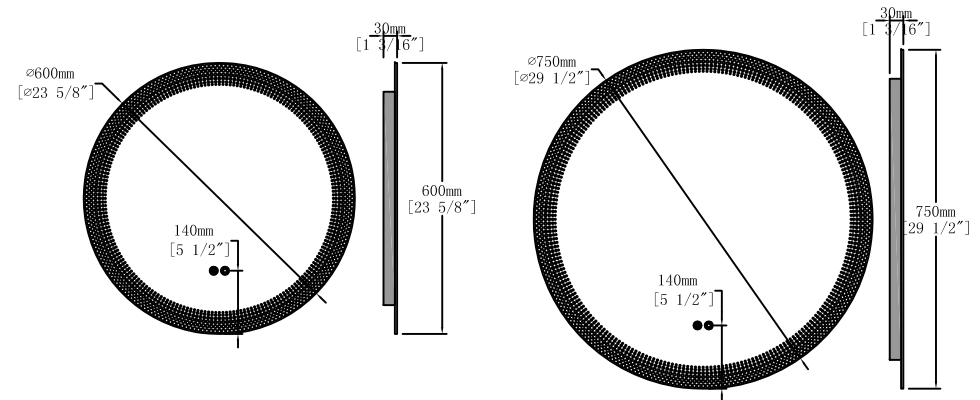

GMB0062424LED

GMB0063030LED

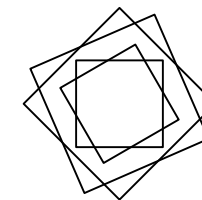



Thank you for shopping with us!

We encourage you to take a few minutes to go through this booklet. It contains important information on installation and care tips to keep your merchandise looking as good as new.

Item NO.: GMB0062424LED / GMB0063030LED

Hardware

Recommended tools

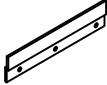
NO.	Draw	QTY
A		3
B		3
C		1

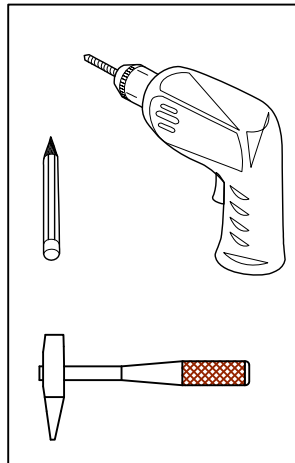

Two Ways Of Connection

1. connect to power source directly by using the plug installed.

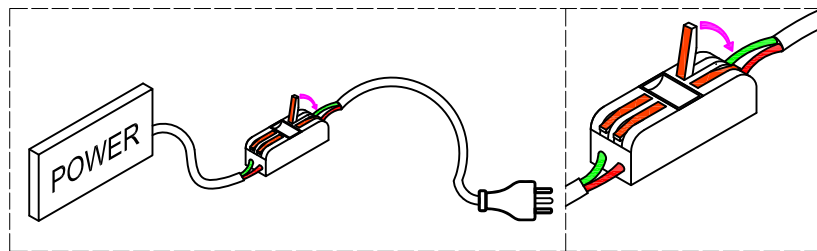

2. Connect by the connector provided. The method as follows:

- remove the plug by pull up the buttons of the connector.
- connect the wire from your home power source to one end of the connect.
- make sure all wires settled firmly.



a

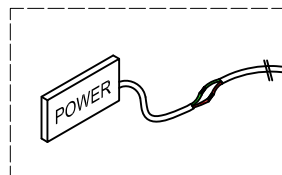

b

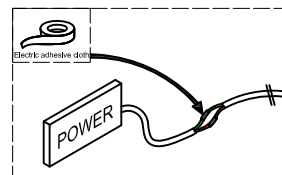

c

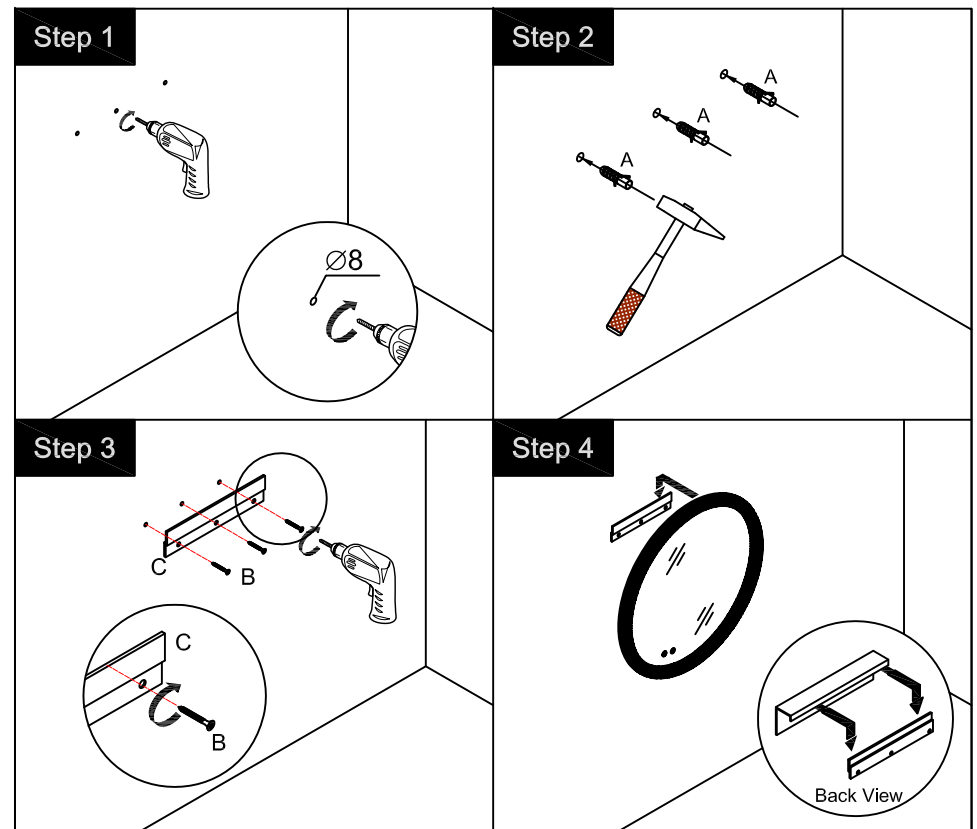

CARE CLEANING AND MAINTENANCE

- The best and safest way to clean your mirror is by using warm water and a soft, lint-free cloth.
- Wring water from the cloth before wiping the mirror to avoid excess moisture.
- Keep bathrooms well ventilated.
- Avoid using cleaners that contain ammonia or vinegar - these can cause corrosion on the edges of the mirror. Never use abrasive cleaners.
- If your mirror sits directly on a vanity, avoid having excess water puddle along the bottom of the mirror.
- Avoid spraying cleaners directly onto the mirror.

